

Spherical plain bearing

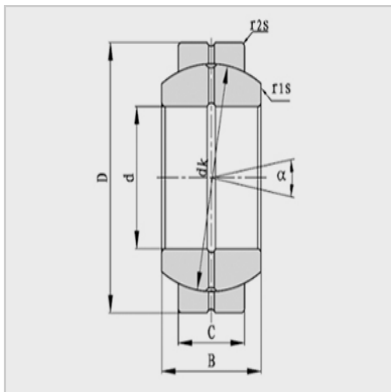
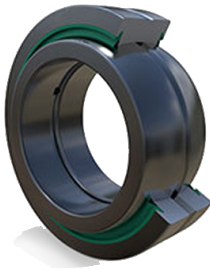

model :

GE..E :	GE90E
GE..ES-2RS :	GE90ES-2RS

Main dimensions (mm) :

d :	90
D :	130
B :	60
C :	50
dk :	115
r1s ( min ) :	1

Main dimensions (mm) :

r2s ( min ) :	1
° :	5

Rated load (KN) :

Cr :	490
Cor :	2450
Weight (kg) :	2.7

: