

Spherical plain bearing

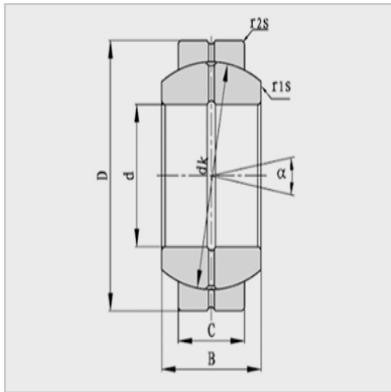
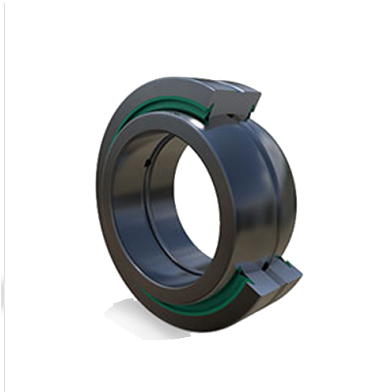

model :

GE..E :	GE120E
GE..ES-2RS :	GE120ES-2RS

Main dimensions (mm) :

d :	120
D :	180
B :	85
C :	70
dk :	160
r1s (min) :	1

Main dimensions (mm) :

r2s (min) :	1
° :	6

Rated load (KN) :

Cr :	950
Cor :	4750
Weight (kg) :	8

: